

Geomagic Wrap[®]

Scan It, Mesh It, Surface It.
In minutes.

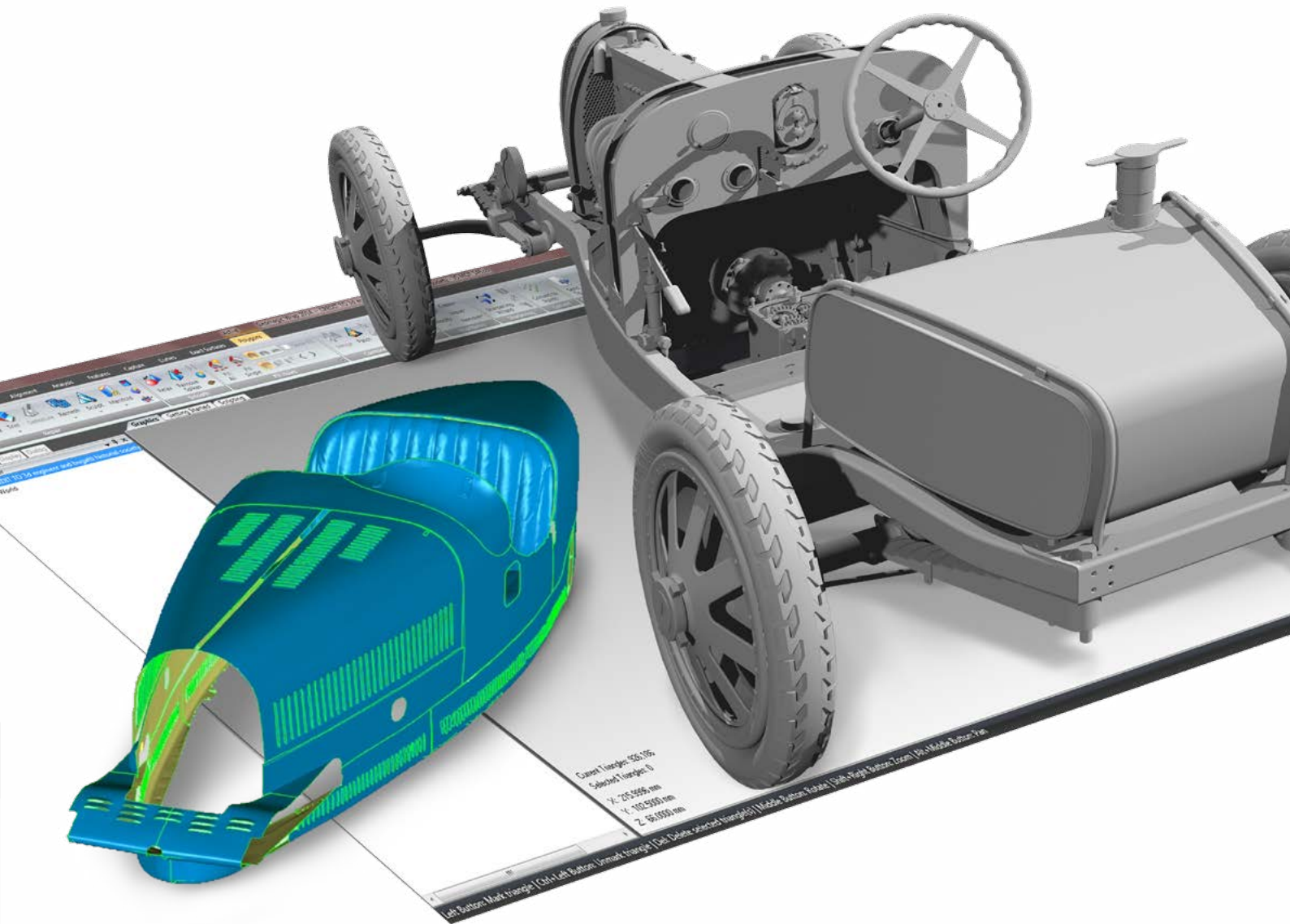



Geomagic Wrap[®]

Geomagic Wrap[®] delivers the industry's most powerful toolbox to transform 3D scan data and imported files into 3D models for immediate use downstream. From engineering to entertainment, art to archaeology and manufacturing to museums, people from every walk of life are effortlessly reverse engineering perfect 3D models from scan data and 3D files using Geomagic Wrap.

Revolutionize Your 3D Workflows

Geomagic Wrap delivers the most easy-to-use, affordable, fast, accurate path from point clouds to 3D polygonal and surface models that can be used instantly in downstream engineering, manufacturing, engineering, art, industrial design and more. As part of your 3D digital thread, Geomagic Wrap provides the digital bridge to allow you to create perfect data to use directly in 3D printing, milling, archiving and multiple other 3D uses.

With Geomagic's advanced Exact Surfacing tools included Geomagic Wrap delivers power yet ease-of-use in cutting-edge modeling functions for that flawless 3D model. Scripting and macros available also automate functions for repetitive tasks during the reverse engineering process.

Accurately and Effortlessly Build Usable 3D Data

Geomagic Wrap enables users to transform point cloud data, probe data and intermingle imported 3D formats (STL, OBJ, etc.) into 3D polygon meshes and surface models for immediate use. Unique automated tools for rapid point cloud cleanup and surfacing allow you to perform complex tasks quickly and with confidence. Color data from 3D scans can be edited and managed, edited and saved as texture maps for your color 3D prints.

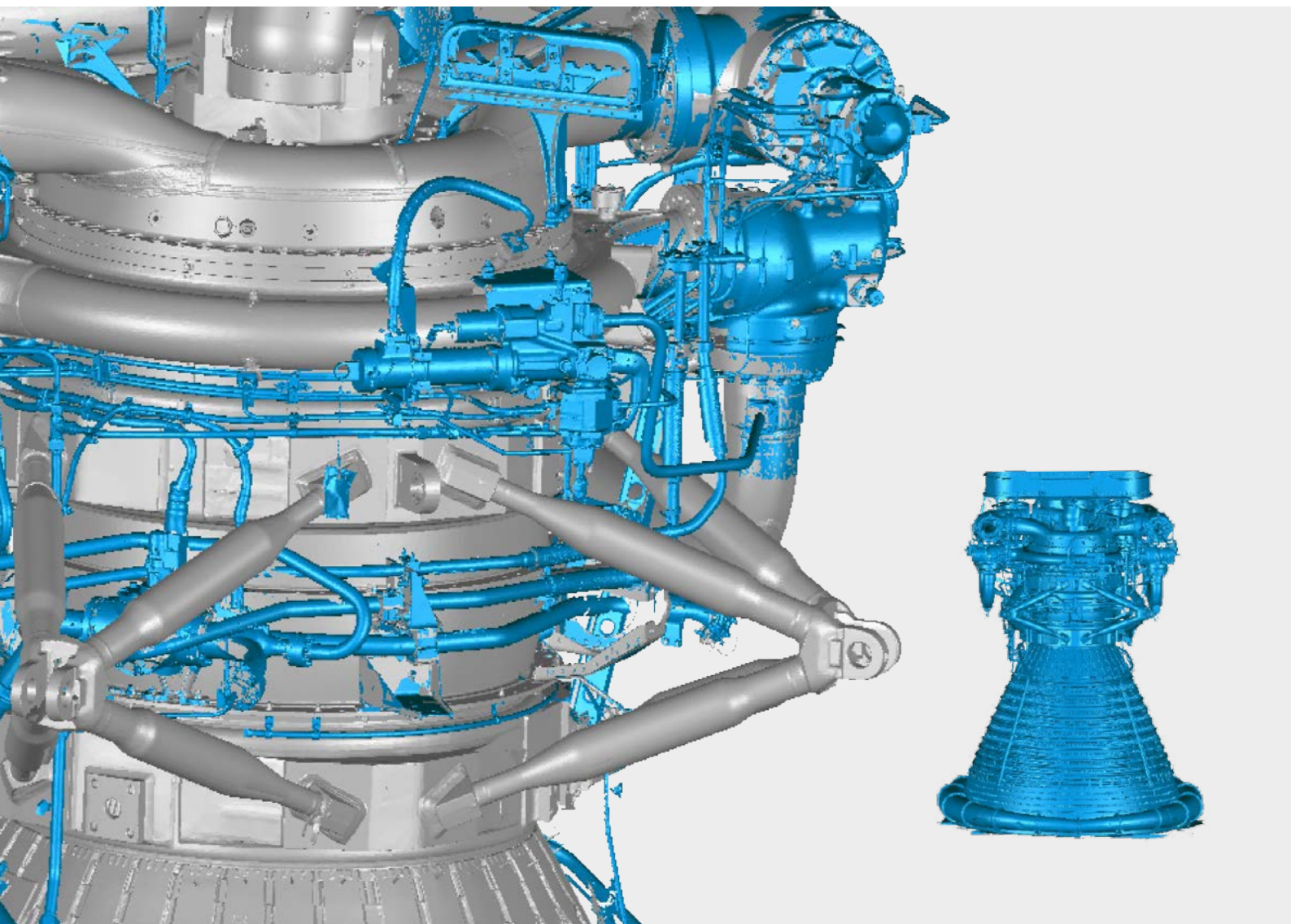

Key Features

Geomagic Wrap's comprehensive toolbox of point cloud and polygon editing features, plus powerful surfacing tools, help you create high-quality 3D models faster.

- Support for the industry's widest range of non-contact 3D scanning and probe devices
- Point cloud editing and fast creation of accurate polygonal models based on the 3D scan data
- Powerful Remesh tool for fast, accurate create clean polygon models from dirty scan data
- Polygon editing tools for hole filling, smoothing, patching and water tight model creation
- Immediately use the data from Geomagic Wrap for 3D printing, rapid prototyping, and manufacturing.
- Render your data immediately in KeyShot to make stunning, photorealistic visualizations of your designs

- Curve and hard feature extraction from polygon bodies for Design from Scan data applications
- Powerful scripting tools enable the extension of Wrap far beyond its off-the-shelf capabilities and the full automation of the routine
- Precise surfacing of the model into NURBS using the easy and comprehensive Exact Surfacing interface
- Extensive Exact Surfacing tools give more control over your surface quality and layout, and allows for total control over NURBS patch layout, surface quality, and continuity.
- File export formats include: WRP, IGES, X_T, SAT, PRC, STEP, VDA, NEU, 3DS, DXF, OOGL, IV, PLY, STL, WRL, OBJ

Primary Industries

- Aerospace
- Heavy equipment
- Medical
- Automotive & Durable Goods
- Electronics
- Tool & Die/Foundry
- Consumer Products
- Archeology
- Art & Entertainment
- Research & Education

Workflows

Scan

Capture realworld data using scanners and probes



Process

Make exact 3D models directly from the captured data



3D Print

Output to 3D print, CNC and other downstream processes

Images Courtesy : USF AIST



Scan

Capture realworld data using scanners and probes

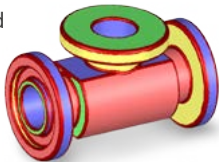

Mesh

Make exact 3D models directly from the captured data

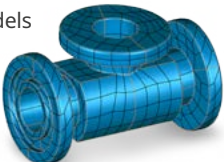

Surface

Transfer 3D surface model to other CAD software

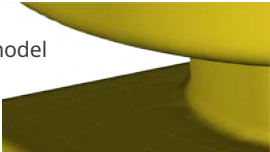

Scan

Capture realworld data using scanners and probes



Mesh

Make exact 3D models directly from the captured data



Render

Use downstream for special effects, movies and more

Images Courtesy : Craig Crane



Geomagic Wrap supports all 3D digitizers, cameras, and scanners in XYZ/ASCII format, and it handles ordered and unordered surface and volume data.

- 3PI - ShapeGrabber
- 3DS - 3D Studio
- AC - Steinbichler
- ASC - generic ASCII
- BIN, SWL - Perceptron
- BRE - Breuckmann
- BTX - Surphaser
- CDK, CDM, RGV, RVM, VVD - Konica Minolta
- COP - Pulsetech
- CWK - Kreon
- DBT - Digibotics
- FLS - Faro LS
- G3D, SURF - GOM
- GPD - Geomagic
- GTI - Genex
- HYM - Hymarc
- ICV - Solutionix
- IV - OpenInventor
- IQMOD, iQWSP, iQSCAN - IQvolution
- MET, MTN - Metron
- MPC, TOC - MantisVision
- NAS - Nastran
- NET - InSpeck
- OPD - Optimet
- OPT - Open Technologies
- PCN - LDI
- PCT - Vialux
- PIX - Roland
- PTX - Leica
- SAB2 - Nikon
- SCN, MGP - Laser Design
- SCN - Next Engine
- SNX - Solutionix
- SWL - ScanWorks Light
- VDA - VDA
- VVD - Vivid
- XYZ - Opton
- XYZN - Cognitens
- ZFS - Zoller & Frohlich

Import/Export:

- 3DS
- OBJ
- DXF
- PLY
- STL
- LWO
- VRML
- WRP
- VTX, ASC
- IGES
- STEP
- Parasolid
- Pro/ENGINEER
- SAT

Contact Information

AMERICAS

geomagic.sales.americas@3dsystems.com
Cary, NC, USA : +1.800.691.1839
Brazil : +55.11.3318.5100
Mexico : +52.(644).114.6401

APAC

geomagic.sales.apac@3dsystems.com
South East Asia : +60.12.398.8473
Australia & New Zealand : +61.450.593.739
India : +91.98404.78347

CHINA

geomagic.sales.china@3dsystems.com
Hotline : +86.400.890.7899

EMEA

geomagic.sales.emea@3dsystems.com
Darmstadt, Germany : +49.6151.357.0

JAPAN

geomagic.sales.japan@3dsystems.com
Tokyo : +81.3.5798.2510

KOREA

geomagic.sales.korea@3dsystems.com
Seoul : +82.2.6262.9900



middle east
3D PRINTING THE FUTURE

3D SYSTEMS
DISTRIBUTOR | Middle East & North Africa

U.A.E Office : 3204, Prism Tower, Business Bay, P.O. Box 28820, Dubai, U.A.E.
K.S.A Office : Al Saif Tower, 6th Floor, King Abdullah Street, Near Intersection with Olaya Street, Riyadh, K.S.A.
Tel : +971.4.443.3853 ; Fax : +971.4.443.3938 ; Email : info@3d-me.com ; Website: www.3d-me.com